

Ecophon Sombra™ A

Ecophon Sombra™ A has an exposed grid system. For applications requiring a black ceiling with low light reflection and good sound absorbing properties. Suitable for social venues such as bars and night clubs.

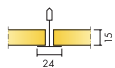

SYSTEM RANGE



Size, mm	600x600	1200x600
Connect T24	•	•
Thickness (THK)	15	15
Inst. Diag.	M74	M74

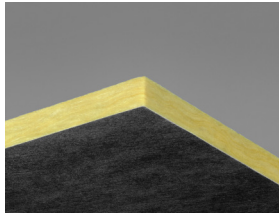

Sombra A tile

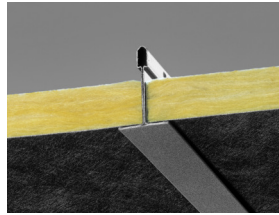

Section of Sombra A system

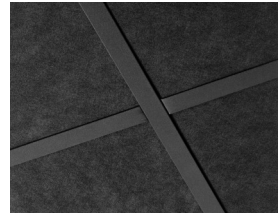

Sombra A system

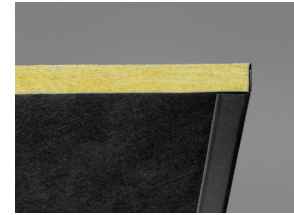

Sombra A with Connect Angle trim black

Acoustic



Sound Absorption:

Test results according to EN ISO 354. Classification according to EN ISO 11654, and the single value ratings for Noise Reduction Coefficient, NRC and Sound Absorption Average, SAA according to ASTM C 423.

α_p , Practical sound absorption coefficient

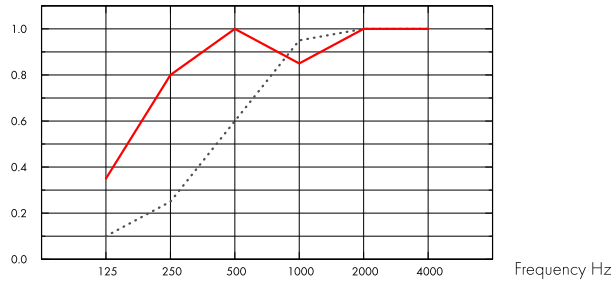

..... Sombra A 15 mm, 50 mm o.d.s.

— Sombra A 15 mm, 200 mm o.d.s.

o.d.s = overall depth of system

	THK mm	o.d.s. mm	α_p , Practical sound absorption coefficient						α_w	Sound absorption class
			125 Hz	250 Hz	500 Hz	1000 Hz	2000 Hz	4000 Hz		
-	15	50	0.10	0.25	0.60	0.95	1.00	1.00	0.55	D
-	15	200	0.35	0.80	1.00	0.85	1.00	1.00	0.95	A

THK mm	o.d.s. mm	NRC	SAA
15	50	0.70	0.71
15	200	0.90	0.91

Indoor Air Quality



Certificate / Label	
Eurofins Indoor Air Comfort®	IAC Gold
French VOC	A+
Finnish M1	•



Environmental Footprint



	kg CO ₂ equiv/m ²
Sombra A	2,14

Life-cycle stages A1 to C4 from EPD, in conformity with ISO 14025 / EN 15804

Circularity



Minimum post-consumer recycled content	55%
Recyclability	Fully recyclable



Fire safety

Country	Class
Europe	EN 13501-1 A2-s1,d0

The glass wool core of the tiles is tested and classified as non-combustible according to EN ISO 1182.



Humidity Resistance

Class C, relative humidity 95% and 30°C, according to EN 13964:2014



Visual appearance

Black 997, nearest NCS colour sample S 9000-N, 3-4% light reflectance.



Cleanability

Weekly dusting and vacuum cleaning.



Accessibility

The tiles are easily demountable. Minimum demounting depth according to installation diagrams.



Installation

Installed according to installation diagrams, installation guides and drawing aid. (The tiles have to be installed according to the arrows on the back of the tile.)



System weight

The weight of the system (including suspension grid) should be approximately 2,5 kg/m².



Mechanical properties

See table about Max live load and Min load bearing capacity and Functional demands, Mechanical properties at www.ecophon.com.



CE

Ecophon ceiling systems are CE marked according to the European harmonized standard EN 13964:2014. CE marked construction products are covered by a Declaration of Performance (DOP) which enables customers and users to easily compare performance of products available on the European market.

INSTALLATION DIAGRAM (M74) FOR ECOPHON SOMBRA A

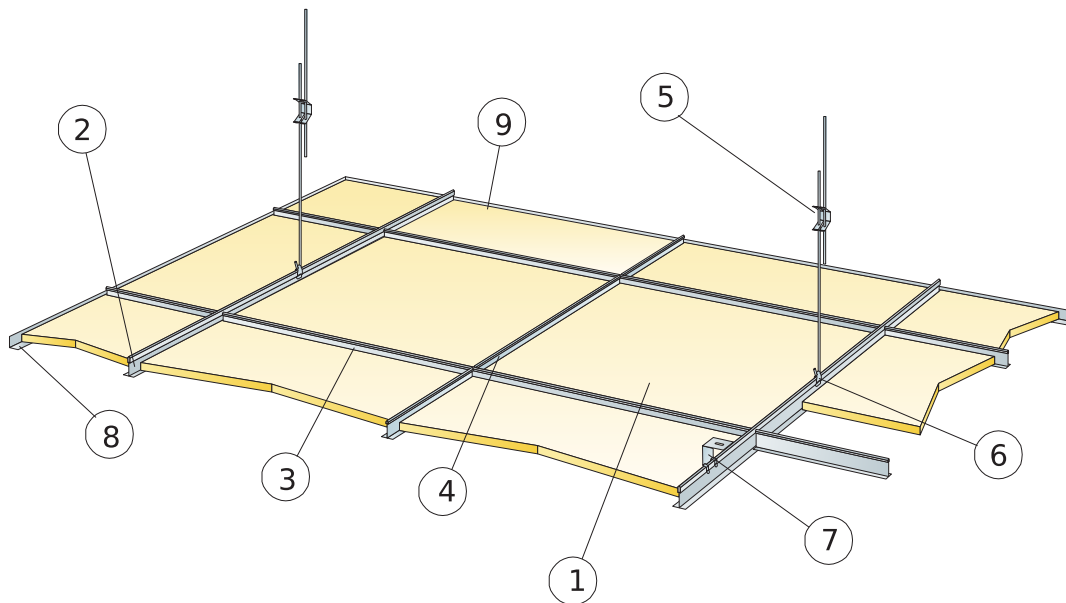

© Ecophon Group

QUANTITY SPECIFICATION (EXCL. WASTAGE)

	Size, mm	
	600x600	1200x600
1 Sombra A	2,8/m ²	1,4/m ²
2 Connect T24 Main runner black, installed at 1200 mm centres (max. distance from wall 600 mm, can be extended up to 1200 mm if no live load between Main runner and wall).	0,9/m ²	0,9/m ²
3 Connect T24 Cross tee black, L=1200 mm, installed at 600 mm centres	1,7/m ²	1,7/m ²
4 Connect T24 Cross tee black, L=600 mm	0,9/m ²	-
5 Connect Adjustable Hanger, installed at 1200 mm centres (max. distance from wall 600 mm)	0,7/m ²	0,7/m ²
6 Connect Hanger Clip (not to be used in swimming hall environments)	0,7/m ²	0,7/m ²
7 For direct installation: Connect Direct Bracket, installed at 1200 mm centres	0,7/m ²	0,7/m ²
8 Connect Angle trim black, (fixed at 300 mm centres)	as required	as required
Δ Min. overall depth of system, with adjustable hanger: 100 mm, with direct bracket: 50 mm	-	-
δ Min. demounting depth: 120 mm	-	-

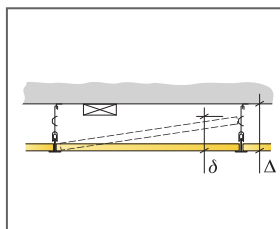

See Quantity specification

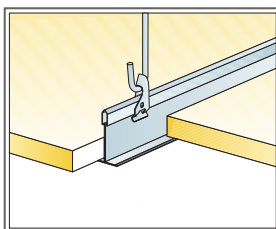

Suspension with adjustable hanger and clip

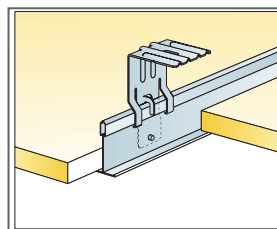

Fixing with direct bracket

Size, mm	Max live load (N)	Min load bearing capacity (N)
600x600x15	50	160
1200x600x15	50	160

Live load/load bearing capacity